

# New products 2024

Our latest highlights





## Our innovations

Pioneering quality products  
made by INOTEC

INOTEC Sicherheitstechnik GmbH has always stood for innovative products that combine high-quality workmanship with optimum functionality. As a company that saves lives with its products in an emergency, reliable quality is our top priority. That is why we place the highest demands on our safety-relevant components.

Our products are 'Made in Germany' and are subject to continuous further development. Development is carried out in-house in accordance with the strictest standards. In this way, we can offer you the usual high product quality of the INOTEC brand. Good reasons to grant you a voluntary warranty of a further three years in addition to the statutory warranty of 24 months, which emphasises our conviction in the quality of our products.

Discover our new products and their advantages on the following pages.



We provide a 5-year  
manufacturer warranty  
on our products!

[inotec.com/warranty](https://inotec.com/warranty)

## Sales and export at INOTEC

We have been successfully selling emergency and safety lighting for almost three decades. Customer proximity has always been at the heart of our work. In Germany, we ensure this through our four sales centres, supported by over 30 dedicated sales representatives.

Our international presence is represented by European trading partners and our subsidiary in the Middle East to ensure our reach and availability across borders.



Contact:  
[inot.ec/en-contact](https://inot.ec/en-contact)

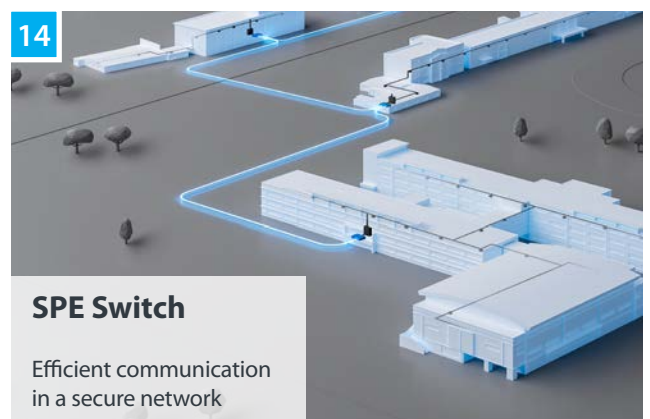
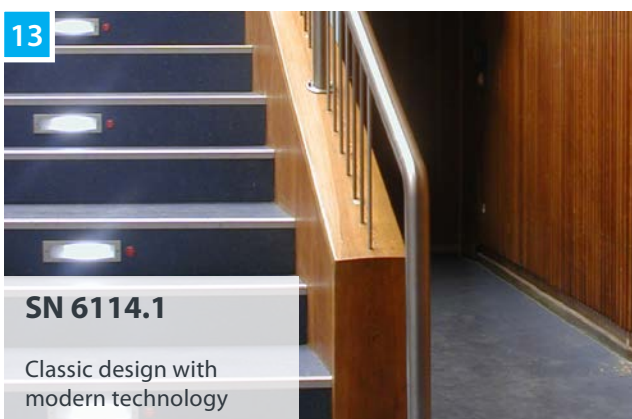
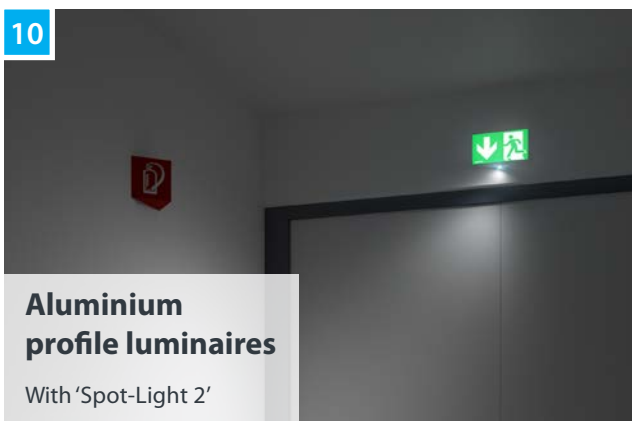



## SN/A 6201

The new combined outdoor luminaire

- + General and emergency lighting combined
- + Housing with high protection rating
- + Light colours 3000 K and 4000 K
- + Individual housing colour possible

With the SN/A 6201, the combined outdoor luminaire is realised in a modern way. The design is based on an INOTEC classic – the SN 6204. Thanks to the robust trapezoidal luminaire housing and the high IP65 protection rating, it is ideal for wall mounting outdoors. Made of die-cast aluminium, the SN/A 6201 has four cable entries for feed-through-wiring for general and emergency lighting and is available in the light colours 3000 K and 4000 K.

Further information:  
[inot.ec/en-sn-a-6201](http://inot.ec/en-sn-a-6201)



## Redundancy for real safety

Outdoors, switched safety luminaires are often used as general lighting at the same time. Or general lighting luminaires are equipped with a monitoring module in order to serve as a safety luminaire at the same time. In both cases, the protection goal is not achieved. If the ballast or the light source fails in one of the luminaires, neither the general lighting nor the safety lighting will function.

Combined luminaires are a better solution. In these luminaires, the technology of two luminaires is combined in one housing. Two LED drivers, one for the general lighting and one for the safety lighting, as well as a light source with two separate LED circuits provide the required redundancy.

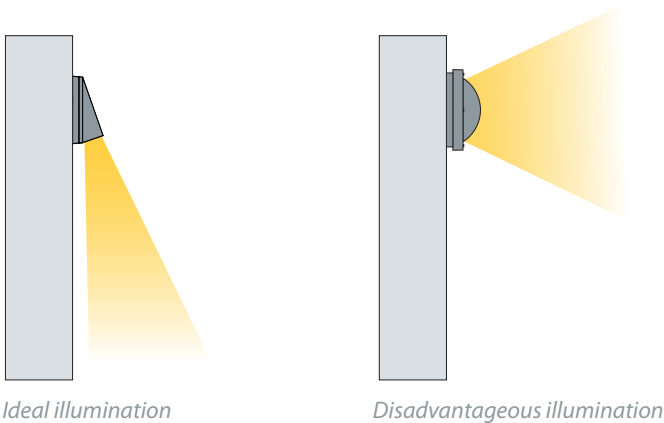
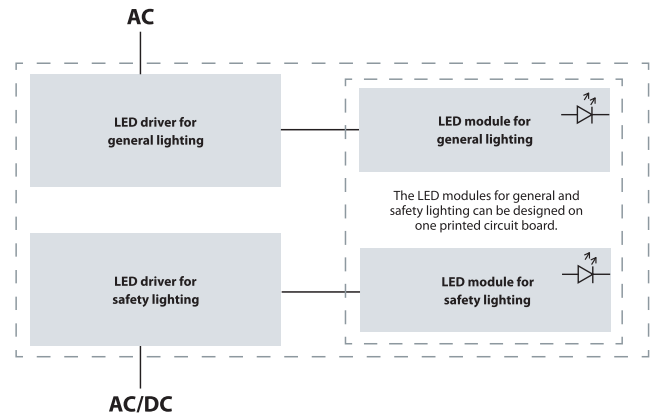

## Directed light – where it is needed

Many night-active insects orientate themselves to moonlight. Artificial light is many times brighter than moonlight and attracts numerous insects, especially if it is undirected light. Many animals are the victims of this light trap. Due to their disorientation, they are eaten, die by exhaustion or are unable to reproduce.

The wall luminaire SN/A 6201 has a downward light emission. This means that the light ends up in the places where it is needed. This not only saves energy, but also protects nocturnal creatures.

## Combined general and emergency lighting

In emergency lighting, EN 1838 requires a minimum illuminance of **1 lux** on the centre line for escape routes. In general lighting, on the other hand, a medium illuminance is planned. For walkways, this depends on the standards applied. According to EN 13201, a mean illuminance ( $E_m$ ) of **5 lux** is used in most cases. In rare cases, 10 lux may be required. For outdoor staircases, 15 lux is generally planned. These requirements for general and safety lighting can be combined in one luminaire with SN/A 6201.

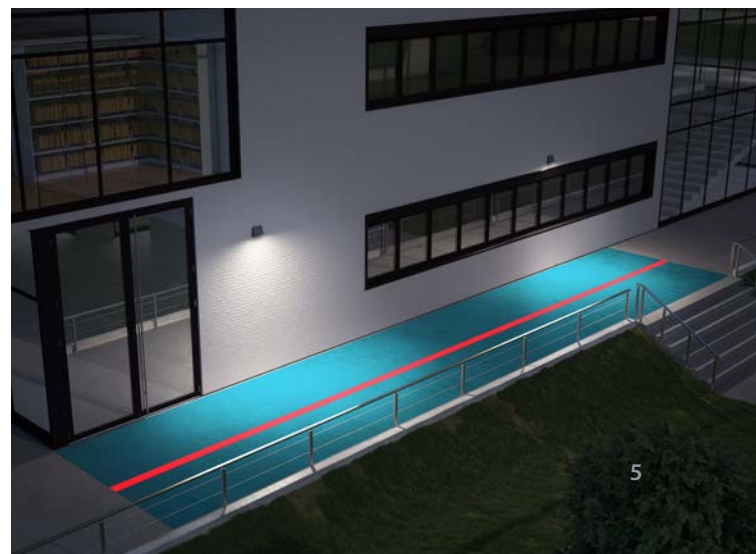



## Housing with high protection rating

The SN/A 6201 is made of high-quality die-cast aluminium. The wall luminaire has a high protection rating of IP65 and has been developed for outdoor use. The quality of the materials used guarantees a long service life.

## Individual colours possible

At INOTEC, only powder coatings are used for luminaire housings. RAL 9016 (traffic white), RAL 7015 (slate grey) and DB 703 are available as standard. On request, RAL colours can be applied according to customer specifications. In this way, the luminaires can be matched to the building facade, for example.

For particularly adverse environments, such as on the coast, the luminaires can be finished with a 2-layer powder coating system (HWF). This further increases the corrosion protection.

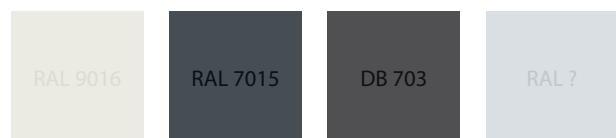

## Various safety lighting versions



- For connection to INOTEC emergency lighting systems with 24 V final circuits
- Rated voltage DC: 24 V  $\pm$ 25 %
- Rated current DC: 185 mA



- For connection to JOKER central battery systems
- Rated voltage DC: 176 – 264 V
- Rated current DC: 24 mA



- For connection to FUSION central battery or mains backup systems
- Rated voltage DC: 176 – 264 V
- Rated current DC: 24 mA

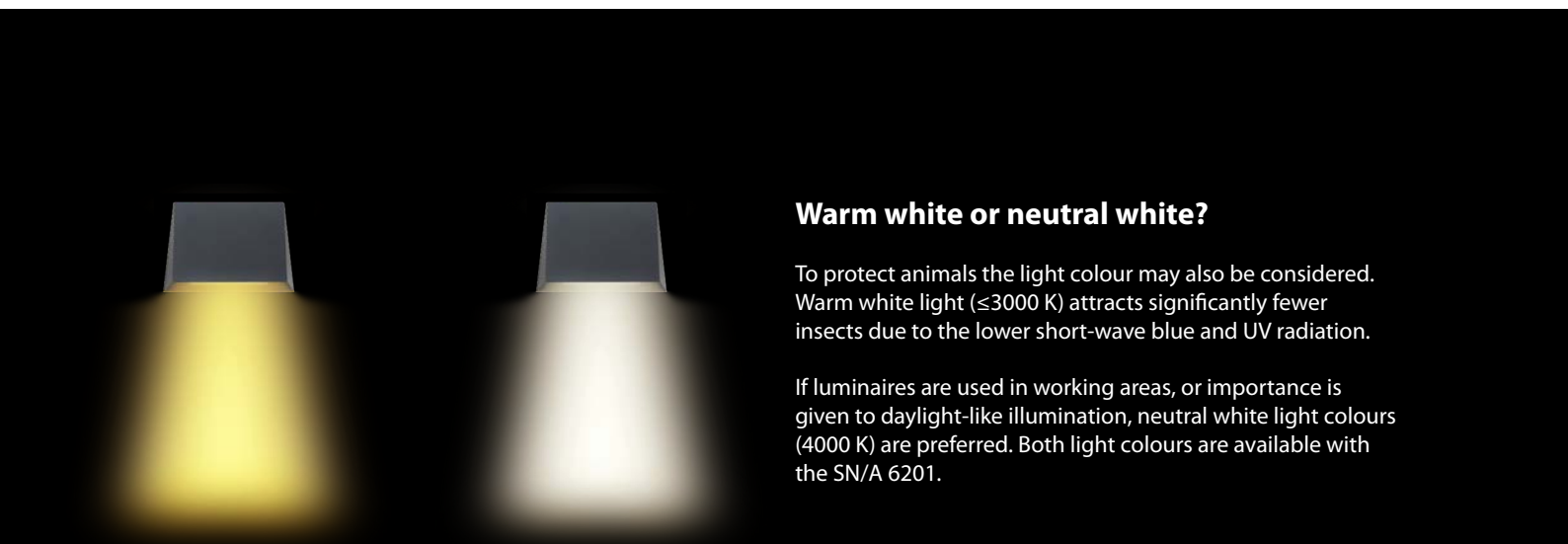

## Warm white or neutral white?

To protect animals the light colour may also be considered. Warm white light ( $\leq$ 3000 K) attracts significantly fewer insects due to the lower short-wave blue and UV radiation.

If luminaires are used in working areas, or importance is given to daylight-like illumination, neutral white light colours (4000 K) are preferred. Both light colours are available with the SN/A 6201.



## Cable entries

The SN/A 6201 has four cable entries for common installation cables. This allows the feed-through-wiring of the emergency lighting and general lighting circuits to be carried out in the luminaire.

## Lateral cable entry

If the emergency lighting or general lighting circuits are surface-mounted, the housing of the SN/A 6201 offers the possibility of cable entry from the side. For the rare cases of surface-mounted cable routing with large cable cross-sections (for example in function preservation), a mounting adapter is available. This adapter expands the possibilities for routing the cables.

## Lighting technology

The combined outdoor luminaire is available in the light colours 3000 K (warm white) and 4000 K (neutral white). The luminous flux of the general lighting part is 967 lm (4000 K) or 918 lm (3000 K). For safety lighting, 376 lm (4000 K) or 360 lm (3000 K) are available. The light emission is directed downwards. This allows the desired lighting to be targeted and insects are not unnecessarily disturbed.

Wall mounting: Minimum illumination 1,0 lx

Distance to escape route centre [m]	Distance to escape route centre					
	1.0 m		2.0 m		3.0 m	
1.0	2.6	6.3	2.4	6.1	1.1	4.7
1.5	3.2	7.7	3.1	7.7	2.5	7.0
2.0	3.6	8.8	3.6	8.9	3.2	8.5
2.5	4.0	9.7	4.0	9.9	3.7	9.6
3.0	4.3	10.5	4.3	10.7	4.2	10.5
3.5	4.5	11.1	4.5	11.4	4.3	11.2
4.0	4.6	11.7	4.7	12.0	4.5	11.9
4.5	4.8	12.2	4.8	12.5	4.7	12.4
5.0	4.8	12.6	4.9	12.9	4.8	12.9
5.5	4.9	12.9	5.0	13.2	4.8	13.2
6.0	4.9	13.1	5.0	13.5	4.9	13.5

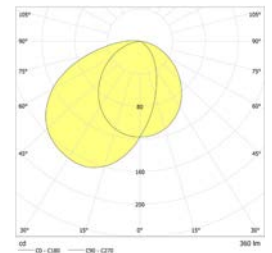

The SN/A 6201 is 'Made in Germany'. All components, starting with the die-cast aluminium housing, continuing with the LED drivers, and ending with the LED light source, are manufactured in Germany by long-standing partners. This is evidence of the high quality and long service life of the luminaires.



## SN 9024.1

The smallest one  
goes big

- + Latest lighting technology
- + Discreet, unobtrusive design
- + Optimised driver for 24 V final circuits
- + Control gear suitable for 38 mm ceiling cut-out

Further information:  
[inot.ec/en-sn-9024-1](http://inot.ec/en-sn-9024-1)



For years, the SN 9024 was the smallest and most unobtrusive LED safety luminaire. Today, the new SN 9024.1 is significantly flatter in profile than its predecessor and impresses with its state-of-the-art lighting technology and ease of installation.





## Classic luminaire re-invented

To make the luminaire even more discreet and efficient, the design and technology of the luminaire are completely re-engineered. The new SN 9024.1 is available with a round ( $\varnothing$  45 mm) and square cover (45 mm x 45 mm).

The profile height of the cover has been reduced from 8 to 2 mm. As a result, the new SN 9024.1 is even more unobtrusive than its predecessor. As before, the mounting hole is only  $\varnothing$  38 mm. The cover and the heat sink are made of high-quality die-cast aluminium, which ensures efficient thermal management for the LED light source.

## Optimised driver and wide colour selection

The LED driver has also been revised. An ILD in a moulded plastic housing replaces the previous 24V LED driver in a metal housing. Its shape allows the supply unit to be installed in ceilings where the distance between the bare ceiling and the suspended ceiling is very small. In addition, there is enough space for feed-through wiring in the housing. So no separate junction boxes need to be installed.

To integrate the safety lighting unobtrusively into the ceiling, the new SN 9024.1 is the perfect solution. To adapt the luminaire even better to the surroundings, (almost) any RAL colour can be applied to the housing on request.

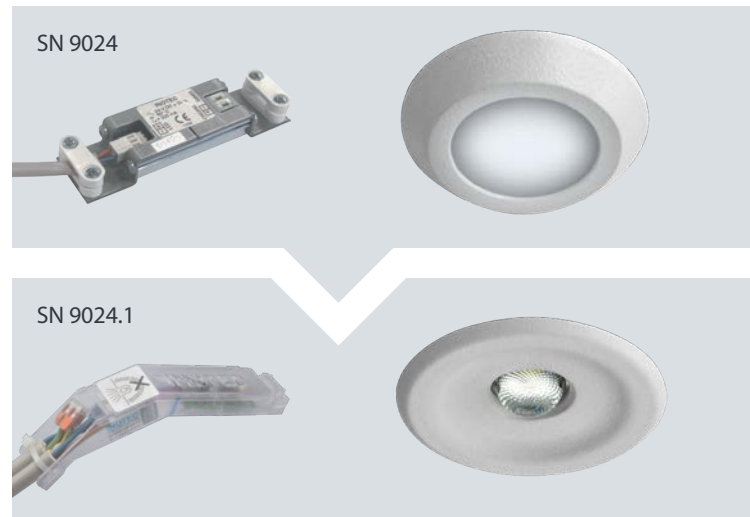

## Secondary optics for any application

The new SN 9024.1 is available with three different secondary optics. Thanks to the powerful LED and the various secondary optics optimised for any application, the power of the LED light source is less than 1 W.

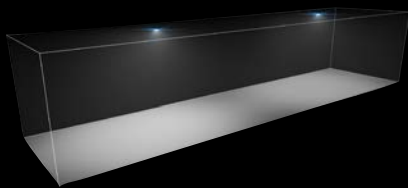

Asymmetric optic for illuminating escape routes

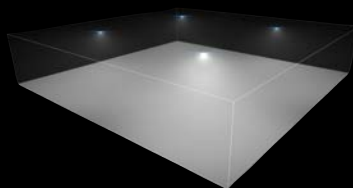

Symmetrical optic for illuminating surfaces

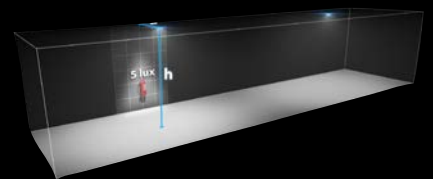

Spot optic for illuminating points of emphasis

## Aluminium profile luminaires

With 'Spot-Light 2' for points of emphasis

- + Quick and easy installation
- + Optional safety luminaire for illuminating points of emphasis
- + High-quality, sophisticated aluminium profile frame

INOTEC aluminium profile luminaires are characterised by their versatility. In addition to the different mounting types, the luminaires are available in different detection distances, which means that they can be used in a variety of projects.

Further information:  
[inot.ec/en-aluprofile](http://inot.ec/en-aluprofile)



## Clear edge – with a minimal surface depth

At only 45 mm depth, the elegant frame can be perfectly integrated into different architectural designs.

Not only in an emergency is the brilliantly illuminated pictogram easy to recognise. But it also turns the luminaire into a real eye-catcher in every room.

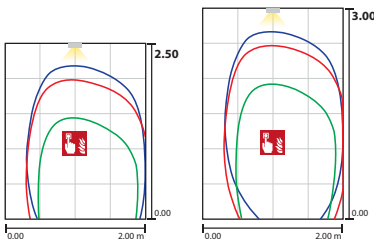
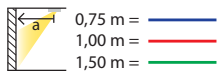
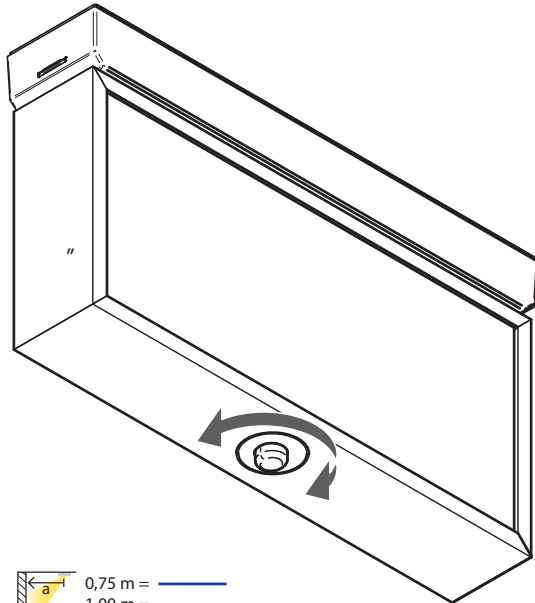

## Universal and versatile usage

INOTEC aluminium profile luminaires are true 'all-rounders' among emergency exit sign luminaires. They are available in 12 m, 20 m, 35 m and even 60 m viewing distance.

Thanks to the various mounting options, such as wall, ceiling and suspended mounting, the luminaires can be installed almost everywhere. Installation is quick and easy. A side cable entry also allows surface-mounted cabling without additional accessories.



## Same function – new design

The optional 'Spot-Light' has been enhanced and is now discreetly integrated into the housing of the luminaires. The 'Spot-Light 2' allows the illumination of points of emphasis with a vertical illuminance of 5 lx in accordance with EN 1838.

The 'Spot-Light 2' is integrated into the escape sign luminaire and can be rotated to align the luminaire with the area to be highlighted. To prevent unintentional or unauthorised rotation at a later time, the 'Spot-Light 2' can be locked inside the emergency exit sign luminaire.

The emergency exit sign luminaire and the integrated 'Spot-Light 2' are supplied, monitored and controlled by one LED driver. In this way, it is possible to operate the emergency exit sign in maintained mode and the 'Spot-Light 2' in non-maintained mode.



## SNP 2460

Flexible and widely visible in four directions

- + 60 m viewing distance
- + Housing with high protection category
- + Customisable pictogram cover

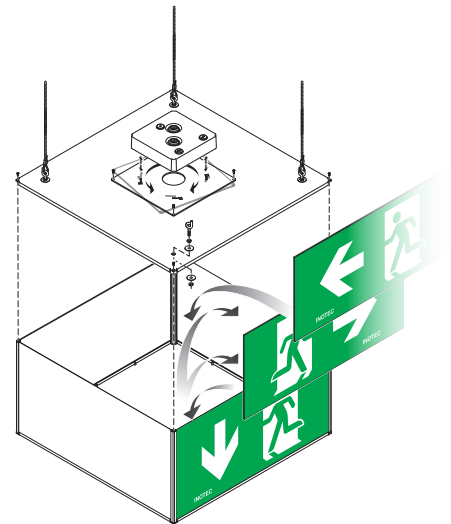

Whether in industry, exhibition halls, logistics centres or other high demanding environments: The four-sided SNP 2460 emergency exit sign luminaire is characterised by its high level of flexibility and durability. The customisable pictogram cover offers great adaptability. The viewing distance of 60 m makes our emergency exit sign luminaire a reliable choice for use in large rooms. Its IP54 protection category offers reliable protection against dust and splash water. The suspension with chain or wire ensures an easy installation adapted to the conditions on site.

Further information:  
[inot.ec/en-snp-2460](http://inot.ec/en-snp-2460)



## SN 6114.1

Classic design with  
modern technology

Housing with high protection category +

Light colours 3000 K and 4000 K +

Individual housing colours are available +

Our robust LED safety light is the ideal solution for illuminating stairs in escape routes. The SN 6114.1 can be installed both in the wall and in steps. A concrete installation housing is available as an option. The luminaire is available in the light colours 3000 K (warm white) and 4000 K (neutral white) so it can be easily integrated into the general lighting concept. Made of high-quality die-cast aluminium, this luminaire offers high resistance and durability. In addition, the luminaire has the protection category IP54, which protects against dust and humidity. This ensures reliable operation even under demanding environments. As a result, SN 6114.1 is ideal for use in heavily frequented areas.



Further information:  
[inot.ec/en-sn-6114-1](http://inot.ec/en-sn-6114-1)

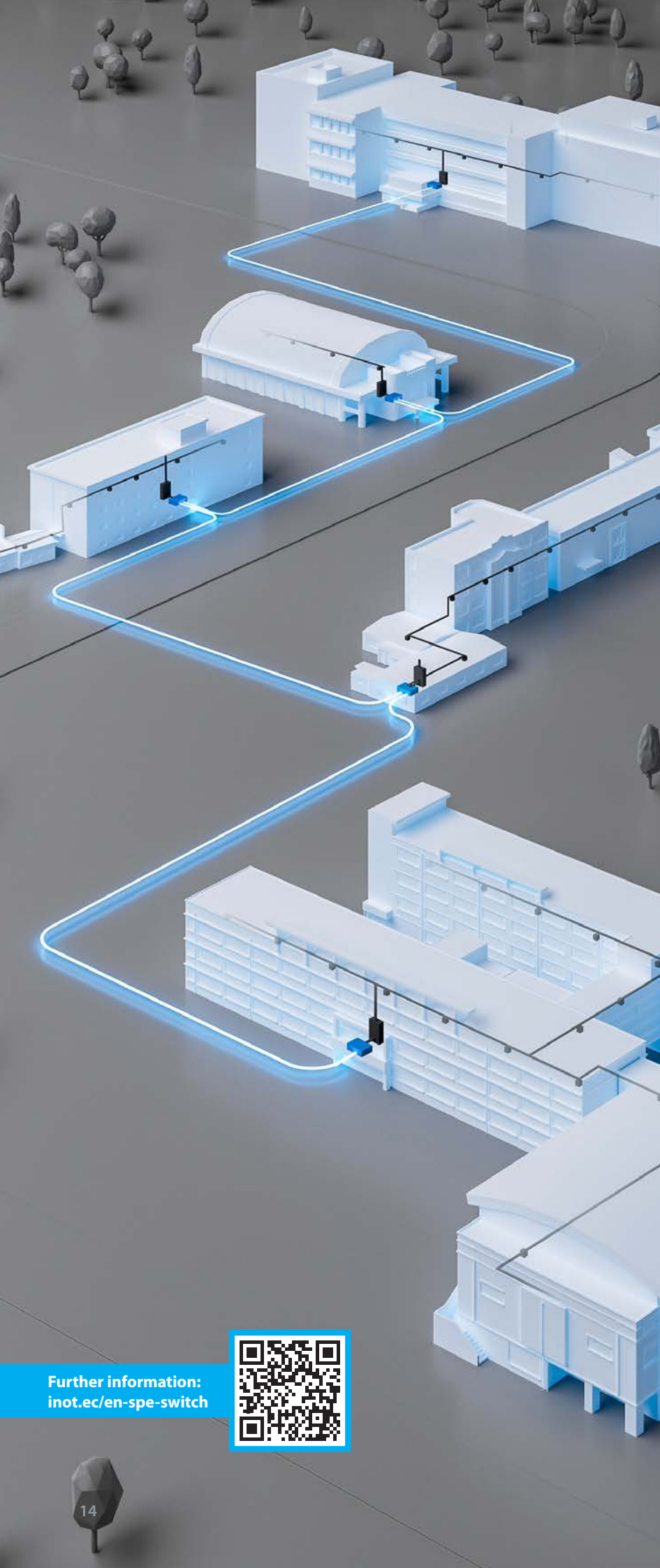

## SPE Switch

Efficient communication  
in a secure network

- + Network communication up to 1 km without additional repeaters
- + Lower project costs due to fewer network components
- + Increased safety due to separate infrastructure for emergency lighting systems

With a transmission rate of 10 MBit/s and a range of up to 1,000 m, our SPE switch enables a fast connection between networks and participants. The module optimises the efficiency of emergency lighting communication and increases data security through the implementation of V-LAN networks. An innovative solution, easy to configure and seamlessly integrated into existing infrastructures – for more efficient and secure corporate networks.

Further information:  
[inot.ec/en-spe-switch](http://inot.ec/en-spe-switch)



## Economical network solution

With a transmission rate of 10 Mbit/s and a cable length of up to 1,000 m, the SPE switch establishes a fast connection between networks and their participants.

If the cable length is too long for the conventional network (>100 m) and the use of commercially available switches or hubs is uneconomical, emergency lighting device networks can be connected and visualised over long distances, for example with the INOView software.

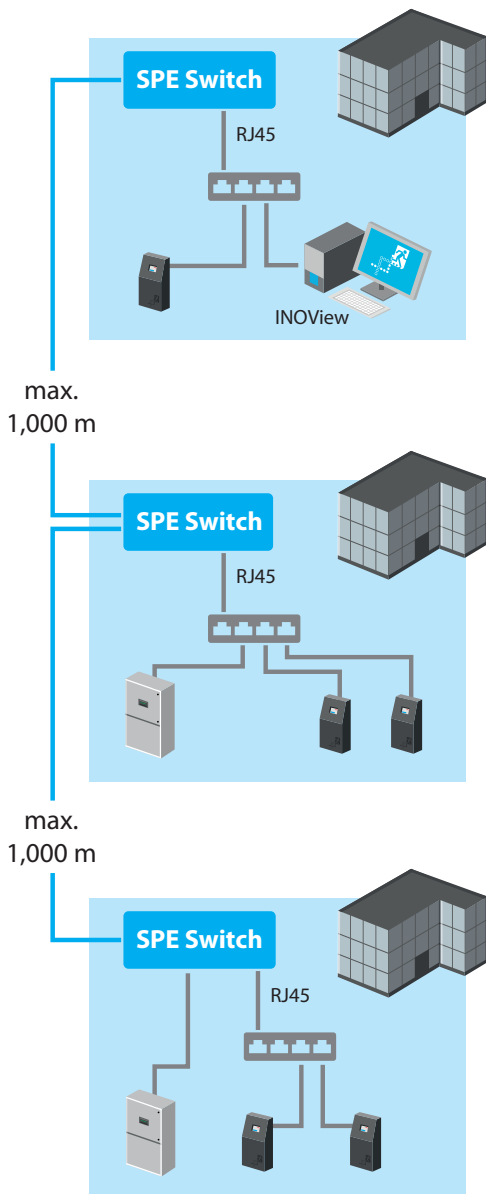

## Technology of the future

The SPE switch establishes a fast 10/100 Mbit connection between network participants over a distance of up to 1,000 m. A 24 V DC voltage is required to supply the SPE switch, which is designed for top-hat rail mounting. A network with various INOTEC emergency lighting devices can be set up at ports 1 and 2 via the RJ45 connections.

A 3-wire connection of up to 1,000 m can be established between a second SPE switch via the SPE1 and SPE2 screw terminals on the output side. Even longer cable lengths can be achieved by using several SPE switches. This connection is used, for example, to ensure monitoring of the INOView visualisation software over long distances.

Typical requirements with a maximum range of 100 m are no longer necessary with SPE technology. The non-administrative SPE switch can also be used universally in networks, not just for INOTEC devices.

More than just light.

**INOTEC**  
Sicherheitstechnik GmbH

🌐 [inotec-licht.de/en](https://inotec-licht.de/en)  
🏢 INOTEC Sicherheitstechnik GmbH  
📷 [inotec\\_sicherheitstechnik](#)